

# PRESTO®

## Professional SaladShooter® electric slicer/shredder

- A great idea for salads and a whole lot more.
- Slices and shreds right where you want.
- Interchangeable cones to make thin slices, thick slices, ripple slices, and shreds. Plus, a funnel guide.

Estas instrucciones también están disponibles en español.

Para obtener una copia impresa:

- Descargar en formato PDF en [www.GoPresto.com/espanol](http://www.GoPresto.com/espanol).
- Envíe un correo electrónico a [contact@GoPresto.com](mailto:contact@GoPresto.com).
- Llame al 1-800-877-0441, oprima 2 y deje un mensaje.

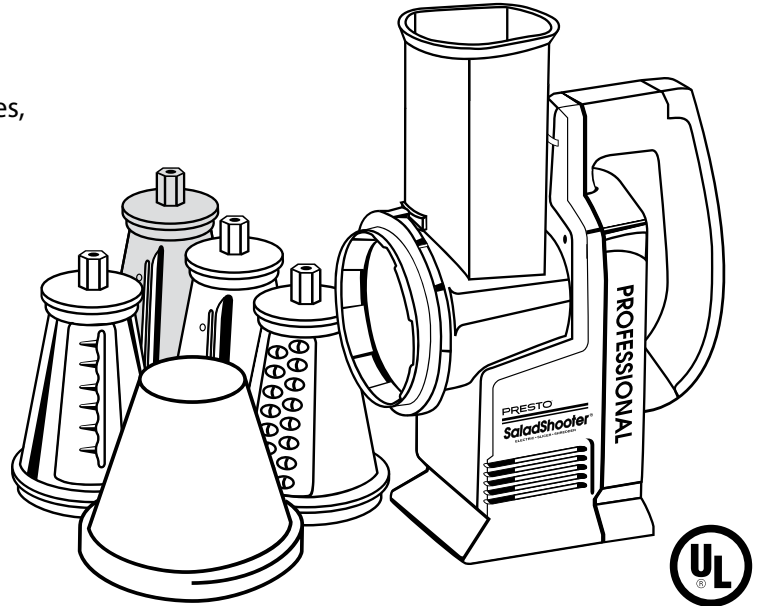

Visit us on the web at [www.GoPresto.com](http://www.GoPresto.com)

©2016 National Presto Industries, Inc.

## INSTRUCTIONS

This is a  Listed appliance. The following important safeguards are recommended by most portable appliance manufacturers.

### IMPORTANT SAFEGUARDS

To reduce the risk of personal injury or property damage when using electrical appliances, basic safety precautions should always be followed, including the following:

1. Read all instructions before using the slicer/shredder.
2. To protect against the risk of electrical shock, never put the motorized base, cord, or plug in water or other liquids.
3. Close supervision is necessary when any appliance is used by or near children.
4. Unplug from outlet when not in use, before putting on or taking off parts, and before cleaning.
5. Do not operate any appliance with a damaged cord or plug or in the event the appliance malfunctions or is dropped or damaged in any manner. Return the appliance to the Presto Factory Service Department for examination, repair, or electrical or mechanical adjustment.
6. The use of attachments not recommended or sold by the appliance manufacturer may cause fire, electric shock, or injury. Use only genuine Presto™ replacement parts.
7. Do not use outdoors.
8. Do not let cord hang over edge of table or counter or touch hot surfaces.
9. Avoid contact with moving parts.
10. Never feed the food through the food chamber with your hands; always use the food guide.
11. Keep fingers out of the slicing/shredding chute.
12. The metal portions of the slicing and shredding cones are sharp. Handle with care.
13. Do not use the slicer/shredder for other than intended use.

**SAVE THESE INSTRUCTIONS**  
THIS PRODUCT IS FOR HOUSEHOLD USE ONLY.

## Important Cord and Plug Information

This appliance has a polarized plug (one blade is wider than the other). To reduce the risk of electric shock, this plug is intended to fit into a polarized outlet only one way. If the plug does not fit fully into the outlet, reverse the plug. If it still does not fit, contact a qualified electrician. Do not attempt to modify the plug in any way. Connect the power supply cord to a 120VAC electrical outlet only.

## WARNING! FOR CALIFORNIA RESIDENTS

State of California Proposition 65 requires that we include the following warning:

This product contains a chemical known to the State of California to cause cancer and birth defects or other reproductive harm.

## Getting Acquainted

Before using your Presto® Professional SaladShooter® electric slicer/shredder, study the diagram below to become familiar with the various parts of the unit and read the instructions carefully.

Before initial use, and after each subsequent use, wash all parts except the motorized base in warm, sudsy water. Wipe the motorized base with a damp cloth to clean. **Never immerse the motorized base in water or any other liquid.**

**Note:** For your convenience, the thin slice cone is gray to differentiate it from the thick slice cone. Thin slices will be approximately  $\frac{1}{16}$ " thick and thick slices will be approximately  $\frac{3}{16}$ " thick.

## How To Use

1. Select one of the slicing or shredding cones. Insert it narrow end first into the slicing/shredding chute (Fig. A). Then attach the twist-lock ring by turning it clockwise until it locks into place (Fig. B).

**CAUTION!** The metal portions of the slicing and shredding cones are sharp. Handle with care.

2. Attach the food chamber assembly to the base by inserting the portion containing the driving end of the slicing or shredding cone into the socket of the motorized base (Fig. C).

Then rotate the food chamber assembly clockwise until it is upright and centered with the handle. To be sure the food chamber assembly is attached properly, check to see that the interlock bracket is positioned in the bracket slot (Fig. D).

**Proper assembly is important.** This unit is designed with safety in mind. The food chamber assembly cannot be removed from the base unless the power switch is in the OFF position. Likewise, the motor will not turn on unless the assembly is attached to the unit.

The motor stops automatically if an incorrectly attached assembly slips off the base during operation. Should the motor stop in the middle of operation, turn the switch to the OFF position. Reassemble, making sure the interlock bracket on the bottom of the slicing/shredding chute is positioned in the bracket slot on the motorized base before using the unit again.

3. The adjustable food guide adapts to small or large loads.

**For small loads,** you will need to separate the two-piece food guide. With the food guide placed in the food chamber, pull the lock tab on the food guide away from the handle and slide the portion of the food guide closest to the handle (this is the portion without the lock tab) up and out of the food chamber (Fig. E, page 3).

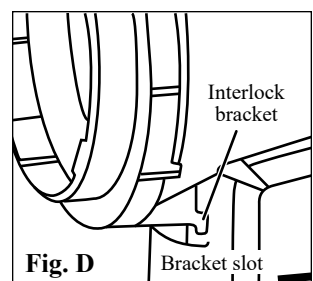
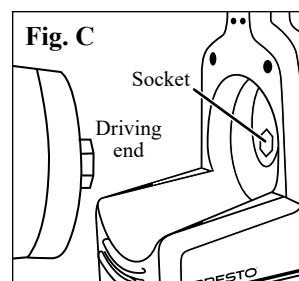
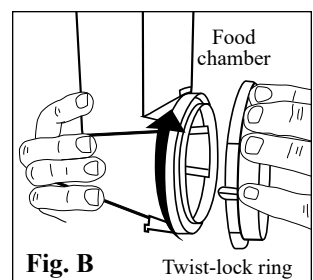
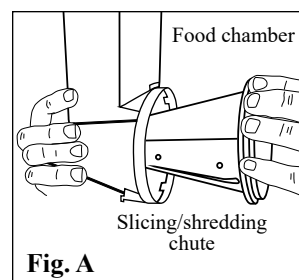
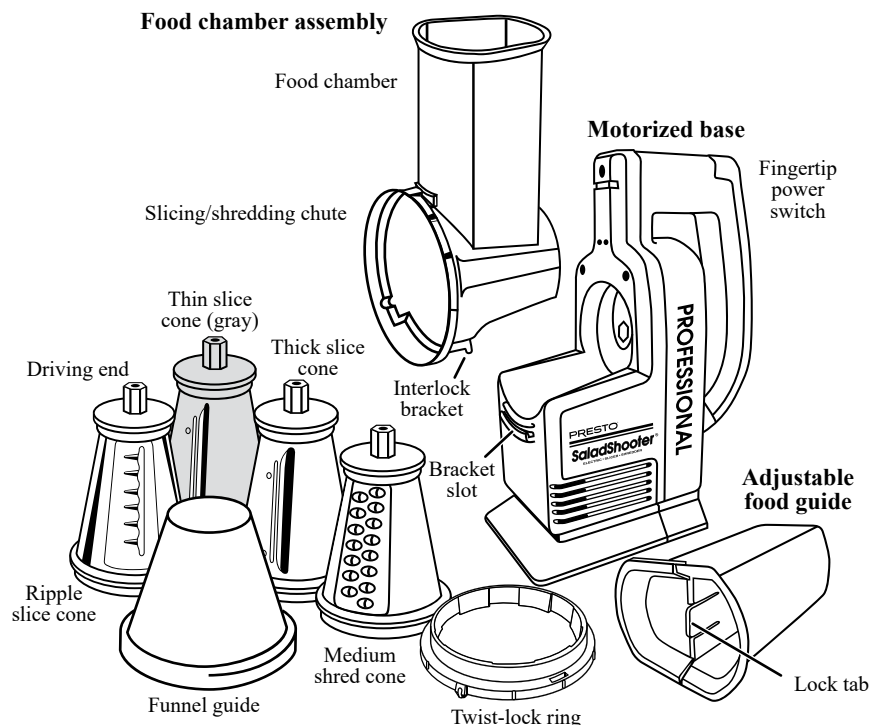

Now place the food you would like processed in the portion of the food chamber closest to the handle (Fig. F). The food should not extend above the top of the food chamber.

Use the part of the food guide that you removed earlier to push the food through the unit during processing (Fig. G). **Make sure the portion of the food guide with the lock tab remains in the food chamber when processing small loads.**

**For large loads,** fill the entire food chamber and use both pieces of the adjustable food guide to slowly push the food through the unit during processing.

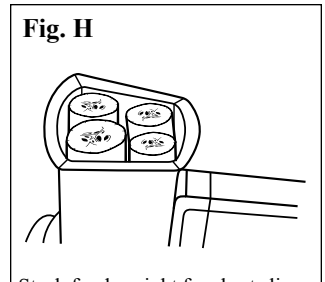
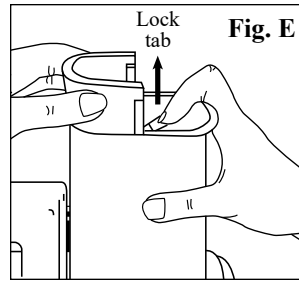

Stack food upright for short slices.

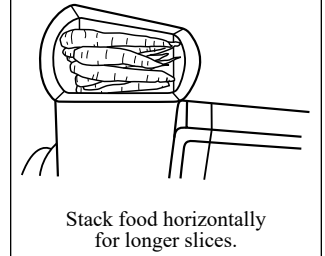
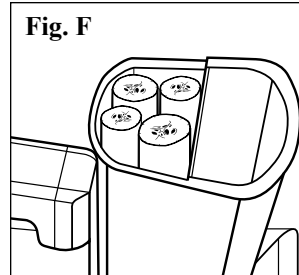

Stack food horizontally for longer slices.

4. For best slicing and shredding results, it is important that the food be prepared properly and placed in the food chamber as follows:

- Cut food so that it will fit easily and loosely into the food chamber. Food that does not fit loosely in the chamber may become wedged and therefore will not discharge properly.

If the food is too large to fit loosely in the food chamber, cut it into smaller pieces. For small loads, use the adjustable food guide as instructed in step 3.

- Stack food into the chamber upright for short slices or horizontally for longer slices (Fig. H).
- Push food through the food chamber using an even pressure on the food guide.

5. If you are going to slice or shred into a small bowl or onto a small area, you may want to use the funnel guide attachment. It directs foods right where you want them.

The attachment simply snaps onto the twist-lock ring (Fig. I). When using the slicer/shredder with the funnel guide attached, hold the unit so that the open end of the funnel is over the spot you wish to shoot the ingredients.

If moist ingredients, such as lettuce and carrots, do not readily come out of the funnel during processing, shake the unit slightly. When using the funnel guide with the slicing cones, be sure the diameter of the sliced food is less than the diameter of the small end of the funnel.

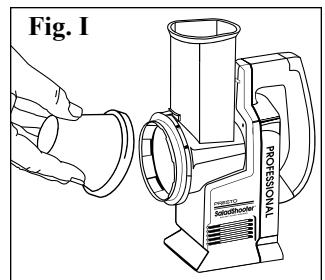
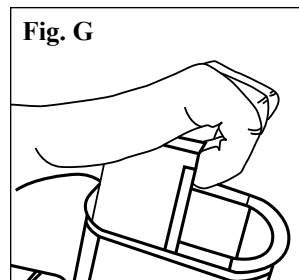

6. Plug the cord into a 120VAC electrical outlet only. Begin slicing or shredding. Use the power switch to turn the unit on and off.

**CAUTION!** To avoid personal injury, never use your hands to push food through the food chamber. Always use the food guide and always keep your hands away from the slicing/shredding chute when the unit is running.

## Suggested Uses

- ◆ Make delicious, healthful salads using your own fresh, hand-selected vegetables for guaranteed goodness.
- ◆ Create beautiful fruit salads with thick and ripple slices of bananas, apples, peaches, nectarines and more.
- ◆ Turn an ordinary frozen pizza into a gourmet delight by adding your own fresh cheese, peppers, mushrooms, olives, onions, etc.
- ◆ Create spectacular vegetable trays with ripple sliced carrots, kohlrabi, radishes, and zucchini.
- ◆ Make luscious pies and tortes with thick and ripple slices of apples, peaches, strawberries, and kiwi.
- ◆ For perfect stir fry, use thin slices of carrots, mushrooms, and zucchini.
- ◆ Chop nuts for baking or garnishing a dessert. Crumb crackers for pie crusts or make bread crumbs for casserole toppings. Use the funnel guide to direct them right where you want them.
- ◆ For terrific tacos, taco salads, and pita sandwiches, use the thick slice cone to shred fresh lettuce.
- ◆ Use the funnel guide to decorate a cream topped pie, a fluffy icing cake, or even a cupcake with shredded baking chocolate.
- ◆ Make delicious, creamy coleslaw by shredding fresh cabbage and carrots. The cabbage can be shredded using the thick slice cone or the medium shred cone depending on the texture you prefer.
- ◆ Shred potatoes for nutritious hash browns or potato pancakes. Use the ripple slice cone for delicious American fries or use the thin slice cone and make homemade potato chips.

- ◆ Make deviled eggs, sandwich spreads, and salad toppings by shredding hard-cooked eggs.
- ◆ Make sensational sweet potato chips with thin slices of sweet potatoes and deep fry or microwave.
- ◆ Dry slices of fruits or vegetables in a home food dehydrator.

### *Use Guide for the Slicing and Shredding Cones*

Insert the slicing or shredding cone in the food chamber as instructed in the “How To Use” section on pages 2 and 3. **CAUTION!** The metal portions of the slicing and shredding cones are sharp. Handle with care.

**Note:** The funnel guide attachment may be used for the functions below for directing foods right where you want them. Follow the instructions in Step 5 on page 3.

Suggested Foods	Medium Shred Cone (white cone)	Thick Slice Cone (white cone)	Thin Slice Cone (gray cone)	Ripple Slice Cone (white cone)
<b>Fruits</b>				
Apples	✓	✓	✓	✓
Bananas		✓		✓
Coconut	✓			
Kiwi		✓		✓
Maraschino Cherries	✓			
Nectarines	✓	✓	✓	✓
Peaches	✓	✓		✓
Pears	✓	✓		✓
Strawberries		✓		✓
<b>Vegetables</b>				
Cabbage	✓	✓	✓	✓
Carrots	✓	✓	✓	✓
Celery		✓	✓	✓
Chili Peppers	✓	✓	✓	✓
Cucumbers	✓	✓	✓	✓
Green Peppers		✓	✓	✓
Lettuce		✓		✓
Mushrooms		✓	✓	✓
Onions		✓	✓	✓
Potatoes	✓	✓	✓	✓
Radishes	✓	✓	✓	✓
Sweet Potatoes	✓	✓	✓	✓
Turnips	✓	✓	✓	✓
Zucchini	✓	✓	✓	✓
<b>Other Foods</b>				
Bread	✓			
Cheese	✓			
Chocolate	✓			
Cookies	✓			
Crackers	✓			
Hard-Cooked Eggs	✓			
Nuts	✓	✓	✓	✓
Olives	✓	✓	✓	✓
Pickles	✓	✓	✓	✓

### Helpful Hints

- ◆ All food slices and shreds better when it is fresh and firm.
- ◆ Semi-soft cheeses should be refrigerated overnight or placed in the freezer for approximately 30 minutes before shredding. Hard cheeses should be at room temperature. All unprocessed cheeses can be shredded successfully with this unit. **It is not recommended that you use soft or processed cheese as it may clog the unit.**

- ◆ Use light pressure on the food guide for thinner slices and shreds, and firm pressure for thicker slices and shreds.
- ◆ Certain soft fruits, such as strawberries and kiwi, should be firm, not overripe, to slice. These types of fruits can also be placed in a freezer for a few minutes before slicing. Certain fruits with tough skins, such as apples, should be peeled before slicing or shredding.
- ◆ Some foods can be double processed. For instance, you can shred carrots and run them through again for grated carrots. Cheese can be shredded twice for grated cheese.
- ◆ Place food upright in the food chamber until it is full. Remember that food should fit easily and loosely into the food chamber and should not extend above the top of the food chamber. Apply pressure evenly with the food guide. Failure to properly load the food chamber or to apply even pressure may result in food falling over in the food chamber. If food falls over in the chamber, slices and shreds may be uneven.
- ◆ It is normal for bits of food remain on the top of the slicing or shredding cone after you have completed processing.
- ◆ The unit is not designed to shred onions, slice cheese or chocolate, or process meats and tomatoes.
- ◆ To avoid personal injury or damage to the unit, do not attempt to slice foods that are too hard to be cut with an ordinary knife.  
**NOTICE:** This slicer/shredder was not designed to chop ice or grind coffee beans. You may damage the unit.

## Questions & Answers

***Occasionally my slicer/shredder will not turn on, or the fingertip power switch works intermittently. Why is this?***

Most likely the food chamber assembly is not attached properly to the motorized base. The fingertip power switch is designed to work only when the food chamber assembly is centered with the handle on the base. Should the power switch operate intermittently, either the ON-OFF latch on the base is not positioned directly between the two tabs on the food chamber (Fig. J) or the interlock bracket on the bottom of the slicing/shredding chute is not positioned in the bracket slot on the base (Fig K). Check the position of the food chamber assembly. Realign it so it is centered properly.

***Sometimes I have trouble disengaging the food chamber assembly from the motorized base? What am I doing wrong?***

You probably forgot to turn the unit off. The unit is designed with a safety feature which prevents the food chamber assembly from being removed when the fingertip power switch is in the ON position.

***How come I sometimes have to use a lot of pressure to get food out of the slicing/shredding chute or no food comes out at all?***

Any of the following may be occurring:

1. You have packed the food chamber too tightly. Foods should fit loosely in the food chamber. Leafy vegetables, such as cabbage and lettuce, should be cut into chunks the size of the food chamber.
2. The food is not fresh and firm. All food slices and shreds better when it is fresh and firm.
3. Pieces of the food being processed may have wrapped around the slicing or shredding cone during processing or may have become wedged in the cone. This would prevent food from coming out. If this occurs, simply disconnect the unit from the outlet, remove the slicing or shredding cone, and clean out the buildup of food.
4. You may be slicing or shredding a hard vegetable, such as a sweet potato, or shredding cheese. Cheese and hard vegetables may require more pressure on the food guide. Sometimes when slicing or shredding hard vegetables or when shredding cheese, the motor may sound as if it is laboring. This is normal.

## Care and Cleaning

Before using for the first time and after each subsequent use, your slicer/shredder should be cleaned thoroughly. All parts, except the motorized base, are completely immersible and dishwasher safe. Wash these parts in warm, sudsy water; rinse and dry. If washing in the dishwasher, use the top rack or the rack farthest away from the heating element. Be sure the parts are positioned so they will not fall through the rack. **Note:** Plastic parts may become stained after processing certain foods such as carrots. Should the unit become stained, clean with a mild abrasive cleaner.

The motorized base may be cleaned with a damp cloth. **Never immerse the motorized base in water or any other liquid.**

When removing the food chamber assembly from the motorized base, be sure the power switch is in the OFF position and the unit is unplugged; the food chamber assembly cannot be removed with the power switch in the ON position.

The unit can be easily stored in a small space, such as a drawer.

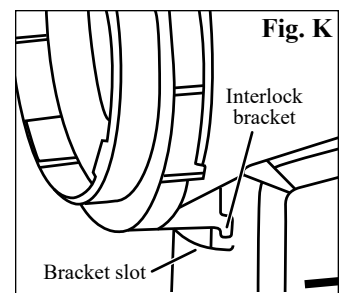
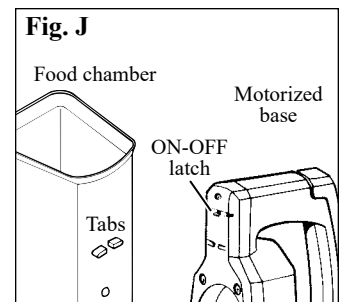

## Consumer Service Information

If you have any questions regarding the operation of your PRESTO® appliance or need parts for your appliance, contact us by any of these methods:

- Call 1-800-877-0441 weekdays 8:00 AM to 4:00 PM (Central Time)
- Email us through our website at [www.GoPresto.com/contact](http://www.GoPresto.com/contact)
- Write: National Presto Industries, Inc.  
Consumer Service Department  
3925 North Hastings Way, Eau Claire, WI 54703-3703

Inquiries will be answered promptly by telephone, email, or letter. When emailing or writing, please include a phone number and a time when you can be reached during weekdays if possible. When contacting the Consumer Service Department, please indicate the model and series numbers for the slicer/shredder. These numbers can be found on the bottom of the slicer/shredder base.

Please record this information:

Model \_\_\_\_\_ Series \_\_\_\_\_ Date Purchased \_\_\_\_\_

The Presto Factory Service Department is equipped to service PRESTO® appliances and supply genuine PRESTO™ replacement parts. Genuine PRESTO™ parts are manufactured to the same exacting quality standards as PRESTO® appliances and are engineered specifically to function properly with its appliances. Presto can only guarantee the quality and performance of genuine PRESTO™ parts. “Look-alikes” might not be of the same quality or function in the same manner. To ensure that you are buying genuine PRESTO™ replacement parts, look for the PRESTO™ trademark.

Canton Sales and Storage Company  
Presto Factory Service Department  
555 Matthews Drive, Canton, MS 39046-3251

### **PRESTO® Limited Warranty**

*(Applies Only in the United States)*

This quality PRESTO® appliance is designed and built to provide many years of satisfactory performance under normal household use. Presto pledges to the original owner that should there be any defects in material or workmanship during the first year after purchase, we will repair or replace it at our option. Our pledge does not apply to damage caused by shipping. ***Outside the United States, this limited warranty does not apply.***

To obtain service under the warranty, please call our Consumer Service Department at 1-800-877-0441. If unable to resolve the problem, you will be instructed to send your PRESTO® appliance to the Presto Factory Service Department for a quality inspection; shipping costs will be your responsibility. When returning an appliance, please include your name, address, phone number, and the date you purchased the appliance as well as a description of the problem you are encountering with the appliance.

We want you to obtain maximum enjoyment from using this PRESTO® appliance and ask that you read and follow the instructions enclosed. Failure to follow instructions, damage caused by improper replacement parts, abuse, misuse, disassembly, alterations, or neglect will void this pledge. This warranty gives you specific legal rights, and you may also have other rights which vary from state to state. This is Presto's personal pledge to you and is being made in place of all other express warranties.

**NATIONAL PRESTO INDUSTRIES, INC.  
EAU CLAIRE, WI 54703-3703**